

LED module sensor

Version date 15-05-2017
www.opple.com

Art. Code	Family Name	
140060553	Accessory	0.05

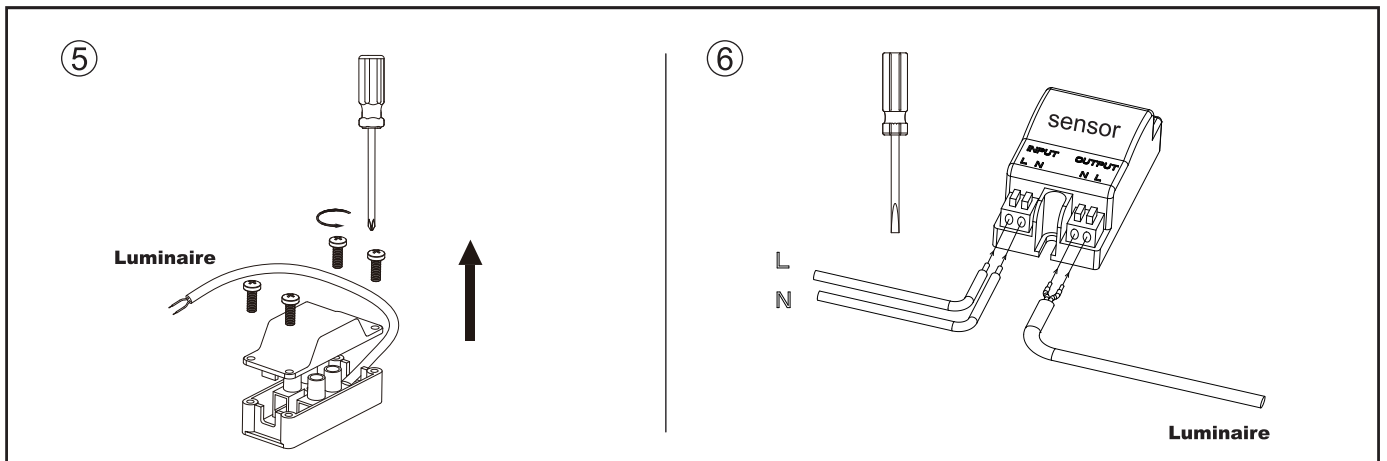

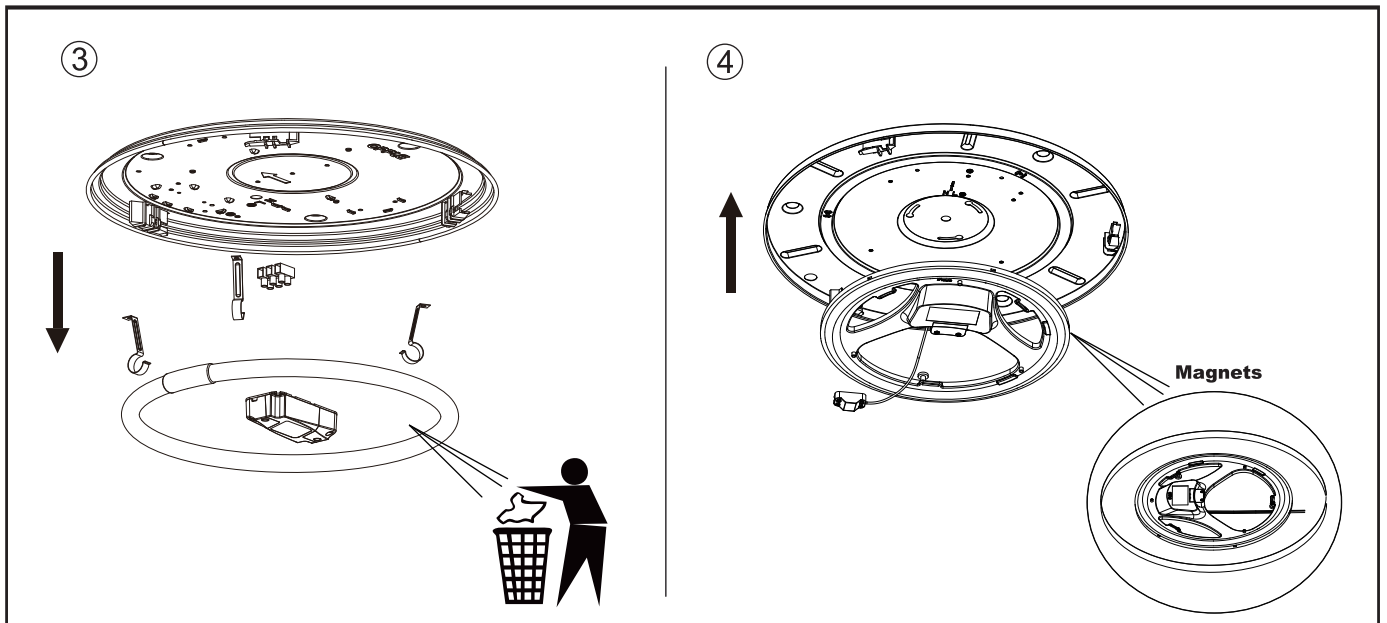
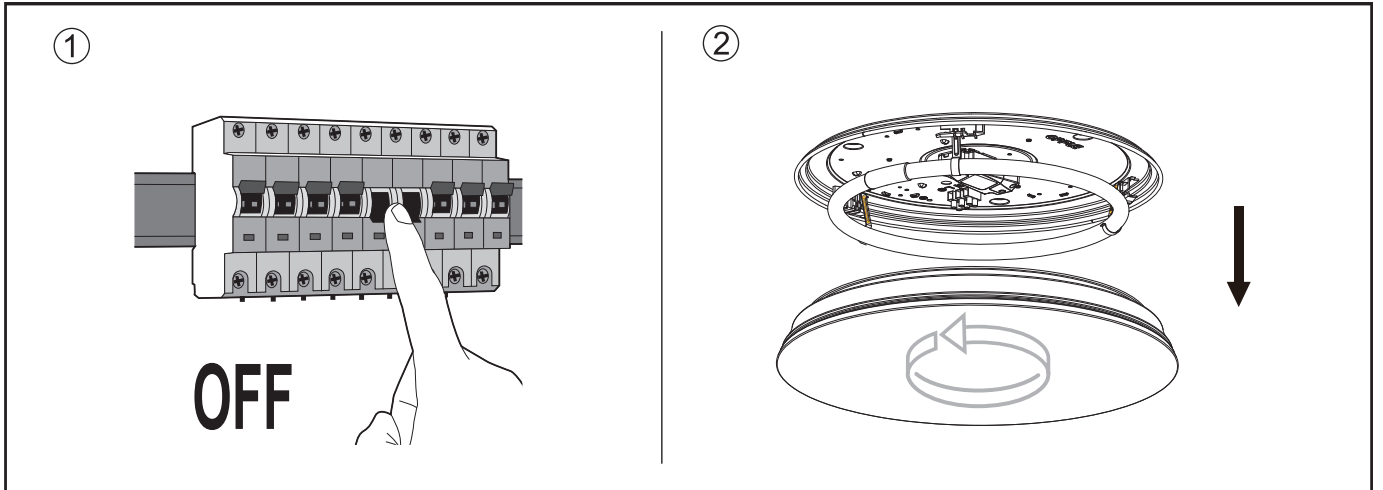
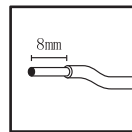
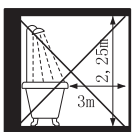
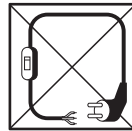
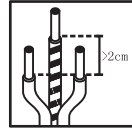
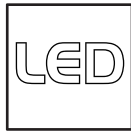
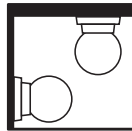
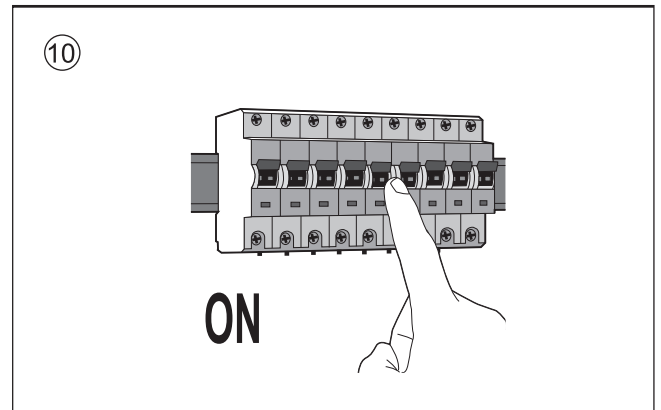
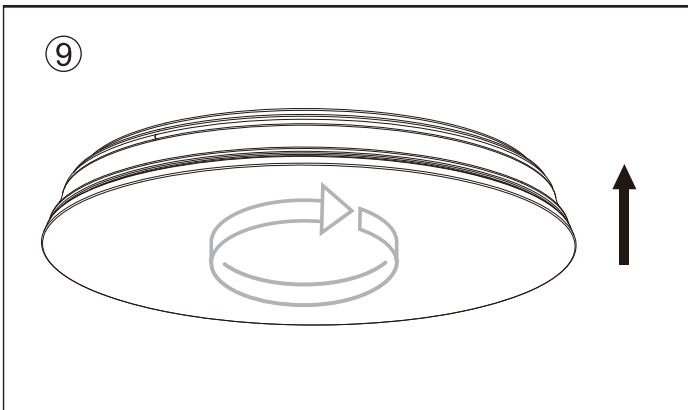
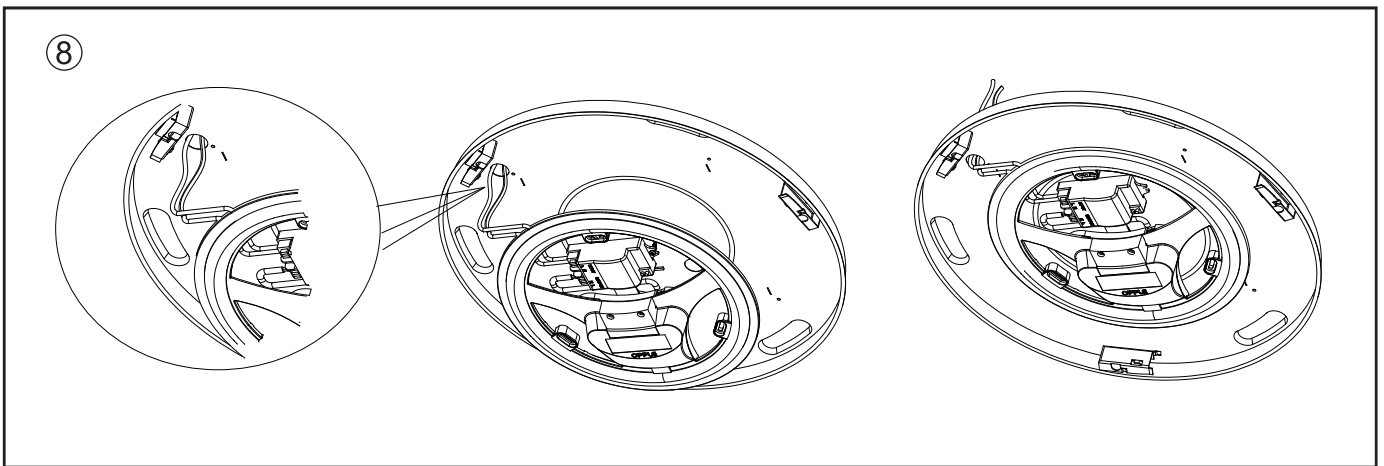
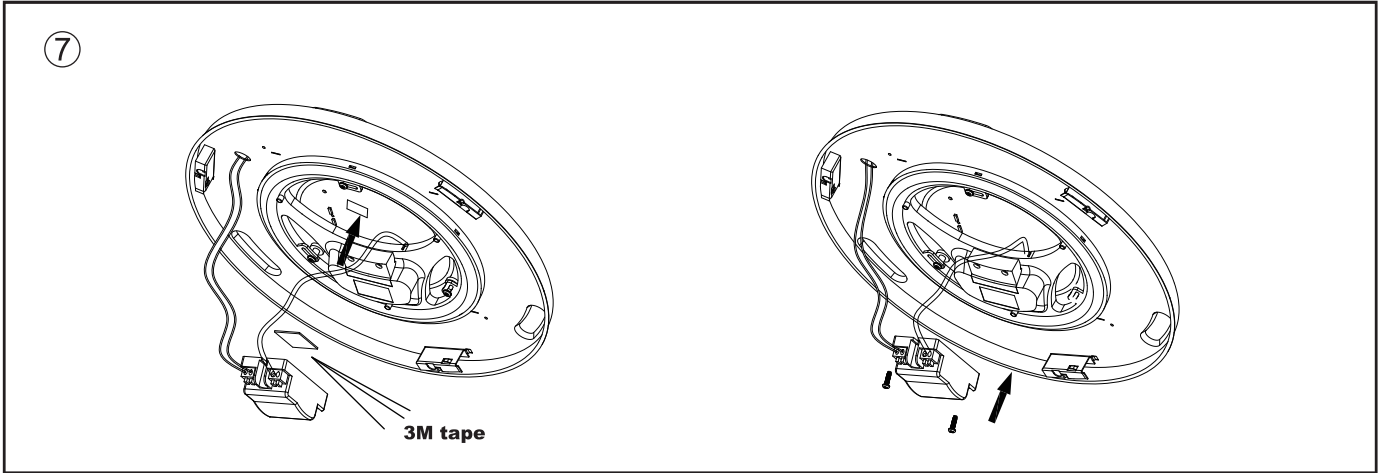

Data subject to change
 Les données sont sujettes à modifications
 Änderungen vorbehalten

Opplé Lighting Electronic (Zhongshan) Co., Ltd.
 528422
 Building A, No.275 Dongan Bei Road,
 Haizhou District, Guzhen Town,
 Zhongshan City, Guangdong, China.

OPPLE Lighting B.V.
 Materiaalweg 6-6A
 5681 RJ Best
 The Netherlands
 service@opple.com
 www.opple.com

Sensor compatible module list:

SAP code	Family name	Weight/KG
140050766	Clio	0.18
140054629	Clio	0.18
140057237	Clio	0.46
140057238	Clio	0.46

The compatibility list is based upon testing conducted with OPPLE modules. Except OPPLE module, the sensor would be able compatible with other ceiling products, the results can vary in certain field application due to a number of factors, in case of doubt regarding the suitability of the application the manufacture of this sensor should be consulted.

Sensor on/off function

Motion sensor + LED driver or ballast (Any brand)



With sufficient light, the lamp doesn't switch on.

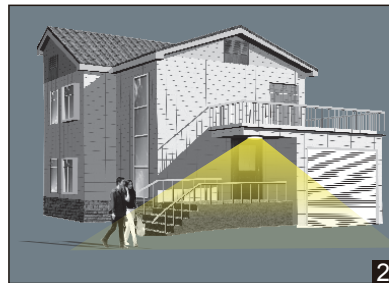

With insufficient ambient light, the sensor switches on the lamp when motion is detected.



After hold time, the sensor switches off the lamp when no motion is detected.

Sensor setting

By selecting the combination on the DIP switch, sensor data can be precisely set for each specific application.

	1	2	3	
ON ↑	ON	ON	ON	100%
II	-	ON	ON	75%
III	ON	-	ON	50%
IV	-	-	ON	25%
V	-	-	-	10%

Detection area

Detection area can be reduced by selecting the combination on the DIP switches to fit precisely each application.

	4	5	6	
ON ↑	ON	ON	ON	5s
II	-	ON	ON	30s
III	ON	-	ON	90s
IV	-	-	ON	3min
V	ON	ON	-	20min
VI	-	-	-	30min

Hold time

Refers to the time period the lamp remains at 100% illumination after no motion detected.

	7	8	9	
ON ↑	ON	ON	ON	2lux
II	ON	ON	-	10lux
III	-	ON	-	25lux
IV	ON	-	-	50lux
V	-	-	-	Disable

Daylight sensor

The sensor can be set to only allow the lamp to illuminate below a defined ambient brightness threshold. When set to Disable mode, the daylight sensor will switch on the lamp when motion is detected regardless of ambient light level. 50lux, 25lux: twilight operation, 10lux, 2lux: darkness operation only.